

36 860 660



- Ausladung 190 mm
- starrer Auslauf
- runder luftangereicherter Strahl
- Bohrungsdurchmesser Auslauf 37 mm
- Bohrungsdurchmesser Einhandbatterie 57 mm
- Rosette für Auslauf Ø 55 mm
- Rosette für Mischer Ø 78 mm
- Durchfluss max. 5,7 l/min
- bleifrei
- Dieses Produkt leistet einen Beitrag zur Erfüllung der Vorgaben von nachhaltigen Gebäudezertifizierungen, z.B. LEED®, BREEAM®, DGNB

	Chrom	36 860 660-00
	Platin gebürstet	36 860 660-06
	Dark Chrome	36 860 660-19
	Light Gold	36 860 660-26
	Light Gold gebürstet	36 860 660-27
	Schwarz matt	36 860 660-33
	Bronze gebürstet	36 860 660-42
	Champagne gebürstet (22kt Gold)	36 860 660-46
	Champagne (22kt Gold)	36 860 660-47
	Chrom gebürstet	36 860 660-93
	Dark Platinum gebürstet	36 860 660-99

Benötigtes Zubehör



- UP-Wand-Einhandbatterie Mischer rechts -** 35 816 970 90
- **ACHTUNG:** Nicht für UP-Montage geeignet. Anschluss über Eckventile, Befestigung über Verschraubung mit der Rückwand.

Benötigtes Zubehör



- UP-Wand-Einhandbatterie -** 35 860 970 90
- Max. Einbautiefe 95 mm
 - Min. Einbautiefe 80 mm

36 860 660

mm [inches]

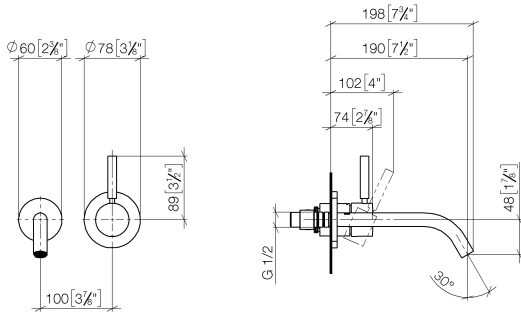

Durchflussdiagramm



Wurfweitendiagramm

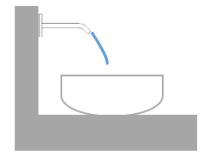
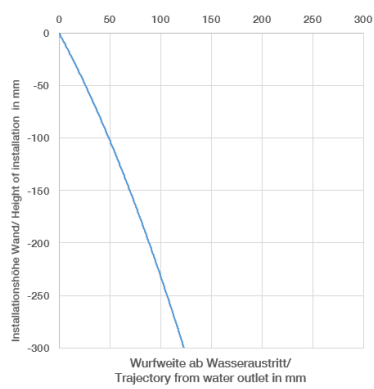

Zertifikate

DVGW_DW- WRAS_2107018. LGA_29898.
6512DN0435.

36 860 660



Ersatzteilstückliste

Nr.	Artikelnummer	Benennung	Verbaumenge	Lieferzeit
1	09 24 03 072 10 90	Nippel	1	2
2	90 24 03 280 00 90	Nippel	1	2
3	09 31 11 112 90	Stift	1	60
4	90 28 22 323 00-00	Auslauf	1	10
5	90 20 66 007 00-00	Griff	1	10
6	09 11 02 288-00	Haube	1	10
7	90 27 62 011 00-00	Rosette	1	10
8	90 15 05 064 01 90	Kartusche	1	2
9	90 30 09 064 00 90	Schlüssel	1	2